

TABLE OF CONTENTS

SECTION 7

DESCRIPTION AND OPERATION OF THE AIRPLANE AND ITS SYSTEMS

7.1	The Airplane	7-1
7.3	Airframe	7-1
7.5	Engine and Propeller	7-2
7.7	Induction System	7-3
7.9	Engine Controls	7-5
7.11	Landing Gear	7-6
7.13	Flight Controls	7-11
7.15	Fuel System	7-12
7.17	Electrical System	7-15
7.19	Vacuum System	7-18
7.21	Pitot-Static System	7-19
7.23	Instrument Panel	7-22
7.25	Cabin Features	7-23
7.27	Baggage Area	7-24
7.29	Heating, Ventilating and Defrosting System	7-26
7.31	Stall Warning	7-27
7.33	Finish	7-27
7.35	Air Conditioning	7-27
7.37	Piper External Power	7-29
7.39	Emergency Locator Transmitter	7-29

TABLE OF CONTENTS

SECTION 7

DESCRIPTION AND OPERATION OF THE AIRPLANE AND ITS SYSTEMS

7.1	The Airplane	7-1
7.3	Airframe	7-1
7.5	Engine and Propeller	7-2
7.7	Induction System	7-3
7.9	Engine Controls	7-5
7.11	Landing Gear	7-6
7.13	Flight Controls	7-11
7.15	Fuel System	7-12
7.17	Electrical System	7-15
7.19	Vacuum System	7-18
7.21	Pitot-Static System	7-19
7.23	Instrument Panel	7-22
7.25	Cabin Features	7-23
7.27	Baggage Area	7-24
7.29	Heating, Ventilating and Defrosting System	7-26
7.31	Stall Warning	7-27
7.33	Finish	7-27
7.35	Air Conditioning	7-27
7.37	Piper External Power	7-29
7.39	Emergency Locator Transmitter	7-29

SECTION 7

DESCRIPTION AND OPERATION OF THE AIRPLANE AND ITS SYTEMS

7.1 THE AIRPLANE

The Arrow IV is a single engine, retractable landing gear, all metal airplane featuring the tail surfaces in a "T" configuration. It has seating for up to four occupants, a 200 pound luggage compartment, and a 200 HP engine.

7.3 AIRFRAME

With the exception of the steel engine mount, the landing gear, miscellaneous steel parts, the cowling, and the lightweight plastic extremities (tips of wings, tail fin, rudder and stabilator), the basic airframe is of aluminum alloy. Aerobatics are prohibited in this airplane since the structure is not designed for aerobatic loads.

The fuselage is a semi-monocoque structure. There is a front door on the right side. A cargo door is installed aft of the rear seat.

The wing is of a conventional design semi-tapered and employs a laminar flow NACA 652-415 airfoil section. The main spar is located at approximately 40% of the chord aft of the leading edge. The wings are attached to the fuselage by the insertion of the butt ends of the spar into a spar box carry-through, which is an integral part of the fuselage structure. The bolting of the spar ends into the spar box carry-through structure, which is located under the aft seats, provides in effect a continuous main spar. The wings are also attached fore and aft of the main spar by an auxiliary front spar and a rear spar. The rear spar, in addition to taking torque and drag loads, provides a mount for flaps and ailerons. The four-position wing flaps are mechanically controlled by a handle located between the front seats. When fully retracted, the right flap locks into place to provide a step for cabin entry. Each wing contains one fuel tank.

A vertical stabilizer, an all-movable horizontal stabilator, and a rudder make up the empennage. The stabilator, which is mounted on top of the fin, incorporates an anti-servo tab which improves longitudinal stability and provides longitudinal trim. This tab moves in the same direction as the stabilator, but with increased travel.

7.5 ENGINE AND PROPELLER

The Arrow IV incorporates a Lycoming IO-360-C1C6 four-cylinder, direct drive, horizontally opposed fuel injected engine rated at 200 horsepower at 2700 RPM. It is furnished with a starter, 60 ampere 14-volt alternator, shielded ignition, vacuum pump drive, fuel pump, propeller governor and a dry automotive type induction air filter. A recommended overhaul period of 1600 hours is based on Lycoming service experience. Operation beyond the recommended time is the decision of the operator. Since Lycoming from time to time revises the recommended overhaul period, the owner should check the latest Lycoming Service Instruction at his Piper dealer for the latest recommended overhaul period and for any additional information.

The aircraft is equipped with a constant speed, controllable pitch propeller. The propeller control is located on the power quadrant between the throttle and mixture controls. A mixture control lock is provided to prevent activation of the mixture control instead of the pitch control.

The exhaust system is a crossover type, which reduces back pressure and improves performance. It is constructed entirely of stainless steel and is equipped with dual mufflers. Cabin heat and windshield defrosting are provided by a heater shroud around the muffler.

An oil cooler is located on the forward lower right side of the fire wall, with the air inlet for the cooler located on the right side of the bottom cowling. A winterization plate is provided to restrict air during winter operation. (See Winterization in Handling and Servicing.)

7.7 INDUCTION SYSTEM

The induction system incorporates a Bendix RSA-5AD1 type fuel injector. The injector is based on the principle of differential pressure, which balances air pressure against fuel pressure. The regulated fuel pressure established by the servo valve when applied across a fuel control (jetting system) makes the fuel flow proportional to airflow. Fuel pressure regulation by the servo valve causes a minimal drop in fuel pressure throughout the metering system. Metering pressure is maintained above most vapor forming conditions while fuel inlet pressure is low enough to allow use of a diaphragm pump. The servo system feature also checks vapor lock and associated starting problems.

The servo regulation meters fuel flow proportionally with airflow and maintains the mixture as manually set for all engine speeds. The fuel flow divider receives metered fuel and distributes fuel to each cylinder fuel nozzle.

The fuel flow portion of the manifold pressure/fuel flow gauge is connected to the flow divider and monitors fuel pressure. This instrument converts fuel pressure to an indication of fuel flow in gallons per hour and percentage of rated horsepower.

The alternate air source of the induction system contains a door that functions automatically or manually. If the primary source is obstructed, the door will open automatically. It may be opened manually by moving the selector on the right side of the quadrant. The primary source should always be used for takeoff.

The pilot should read and follow the procedures recommended in the Lycoming Operator's Manual for this engine, in order to obtain maximum engine efficiency and time between engine overhauls.

7.9 ENGINE CONTROLS

Engine controls consist of a throttle control, a propeller control and a mixture control lever. These controls are located on the control quadrant on the lower center of the instrument panel (Figure 7-1) where they are accessible to both the pilot and the copilot. The controls utilize teflon-lined control cables to reduce friction and binding.

The throttle lever is used to adjust the manifold pressure. It incorporates a gear up warning horn switch which is activated during the last portion of travel of the throttle lever to the low power position. If the landing gear is not locked down, the horn will sound until the gear is down and locked or until the power setting is increased. This is a safety feature to warn of an inadvertent gear up landing.

The propeller control lever is used to adjust the propeller speed from high RPM to low RPM.

The mixture control lever is used to adjust the air to fuel ratio. The engine is shut down by the placing of the mixture control lever in the full lean position. In addition, the mixture control has a lock to prevent activation of the mixture control instead of the pitch control. For information on the leaning procedure, see the Avco-Lycoming Operator's Manual.

The friction adjustment lever on the right side of the control quadrant may be adjusted to increase or decrease the friction holding the throttle, propeller, and mixture controls in a selected position.

The alternate air control is located to the right of the control quadrant. When the alternate air lever is in the up, or closed, position the engine is operating on filtered air; when the lever is in the down, or open, position the engine is operating on unfiltered, heated air.

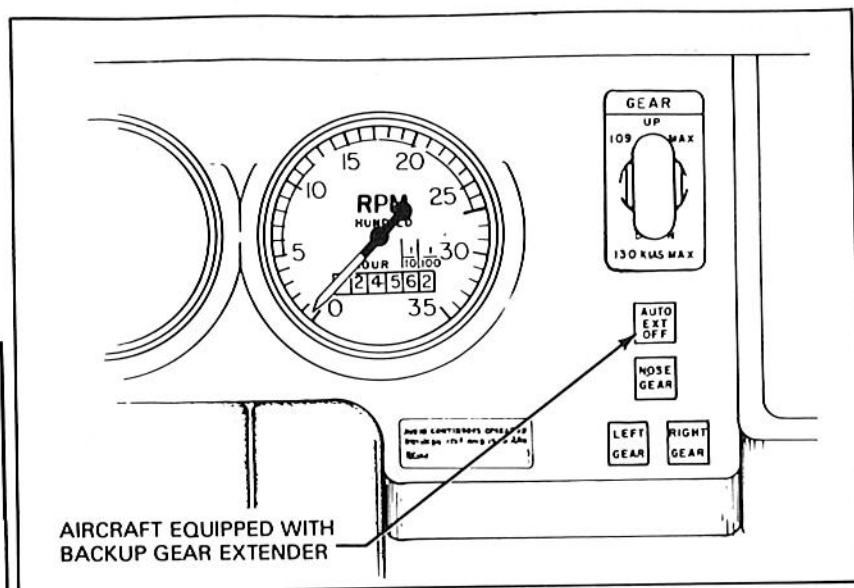

LANDING GEAR SELECTOR
Figure 7-3

7.11 LANDING GEAR

The Arrow IV is equipped with a retractable tricycle landing gear, which is hydraulically actuated by an electrically powered reversible pump. The pump is controlled by a selector switch on the instrument panel to the left of the control quadrant (Figure 7-3). The landing gear is retracted or extended in about seven seconds.

Some aircraft also incorporate a pressure sensing device in the system which lowers the gear regardless of gear selector position, depending upon airspeed and engine power (propeller slipstream). Gear extension is designed to occur, even if the selector is in the up position, at airspeeds below approximately 95 KIAS with power off. The extension speeds will vary from approximately 75 KTS to approximately 95 KIAS depending on power settings and altitude. The device also prevents the gear from retracting at airspeeds below approximately 75 KTS with full power, though the selector switch may be in the up position. This speed increases with reduced power and/or increased altitude. Manual override of the device

is provided by an emergency gear lever located between the front seats to the left of the flap handle (refer to Figure 7-9). The sensing device operation is controlled by differential air pressure across a flexible diaphragm which is mechanically linked to a hydraulic valve and an electrical switch which actuates the pump motor. A high pressure and static air source for actuating the diaphragm is provided in a mast mounted on the left side of the fuselage above the wing. Any obstruction of the holes in this mast will cause the gear to extend. An optional heated mast is available to alleviate obstruction in icing conditions. The optional heated mast is turned on whenever the "PITOT HEAT" is turned on.

WARNING

Avoid ejecting objects out of the pilot storm window which could possibly enter or obstruct the holes in the mast.

The emergency gear lever, when placed in the raised position, can be used to override the system, and gear position is then controlled by the selector switch regardless of airspeed/power combinations. The emergency gear lever is provided with a locking device which may be used to lock the override lever in the up position. The lock is located on the left side panel of the console below the level of the manual override lever. To lock the override lever in the up position, raise the override lever to the full up position and push the pin in. A yellow warning light located below the gear selector switch (Figure 7-3) flashes to warn the pilot that the automatic gear lowering system is disabled. The lock is spring-loaded to the off position to aid disengagement. To disengage the lock raise the override lever and release. The lever will return to its normal position and the yellow flashing light will extinguish. The lever must also be locked in the raised (up) position when gear-up stalls are practiced.

The emergency gear lever, when used for emergency gear extension of the gear, manually releases hydraulic pressure to permit the gear to free-fall with spring assistance on the nose gear. The lever must be held in the downward position for emergency extension.

Gear down and locked positions are indicated by three green lights located below the selector, and a red "Warning Gear Unsafe" light is located at the top of the panel. An all lights out condition indicates the gear is up. The landing gear should not be retracted above a speed of 109 KIAS and should not be extended above a speed of 130 KIAS.

The main landing gear uses 6.00 x 6 wheels. The main gear incorporate brake drums and Cleveland single disc hydraulic brake assemblies. The nose wheel carries a 5.00 x 5 four ply tire and the main gear use 6.00 x 6 six ply tires. All three tires are tube type.

A micro-switch in the throttle quadrant activates a warning horn and red "Warning Gear Unsafe" light under the following conditions:

- (a) Gear up and power reduced below approximately 14 inches of manifold pressure.
- (b) On aircraft equipped with the backup gear extender, if the system has extended the landing gear and the gear selector is up, with the power reduced below approximately 14 inches of manifold pressure.
- (c) Gear selector switch "UP" while on the ground and throttle in retarded position.

On aircraft which are NOT equipped with the backup gear extender an additional switch is installed which activates the warning horn and light whenever the flaps are extended beyond the approach position (10°) and the landing gear are not down and locked.

The gear warning horn emits a 90 cycle per minute beeping sound in contrast to the stall warning horn which emits a continuous sound.

The nose gear is steerable through a 30 degree arc each side of center through the use of the rudder pedals. As the nose wheel retracts, the steering linkage disengages to reduce rudder pedal loads in flight. The nose wheel is equipped with a hydraulic shimmy damper to reduce nose wheel shimmy. A bungee assembly is also included to reduce ground steering effort and to dampen shocks and bumps during taxiing.

The oleo struts are of the air-oil type, with normal extension being 2.75 + .25 inches for the nose gear and 2.5 + .25 inches for the main gear under normal static load (empty weight of airplane plus full fuel and oil).

The standard brake system includes toe brakes on the left and right set of rudder pedals and a hand brake located below and near the center of the instrument panel. The toe brakes and the hand brake have individual brake cylinders, but all cylinders use a common reservoir. The parking brake is incorporated in the lever brake and is operated by pulling back on the lever and depressing the knob attached to the top of the handle. To release the parking brake, pull back on the brake lever; then allow the handle to swing forward.

**SECTION 7
DESCRIPTION/OPERATION**

**PIPER AIRCRAFT CORPORATION
PA-28RT-201, ARROW IV**

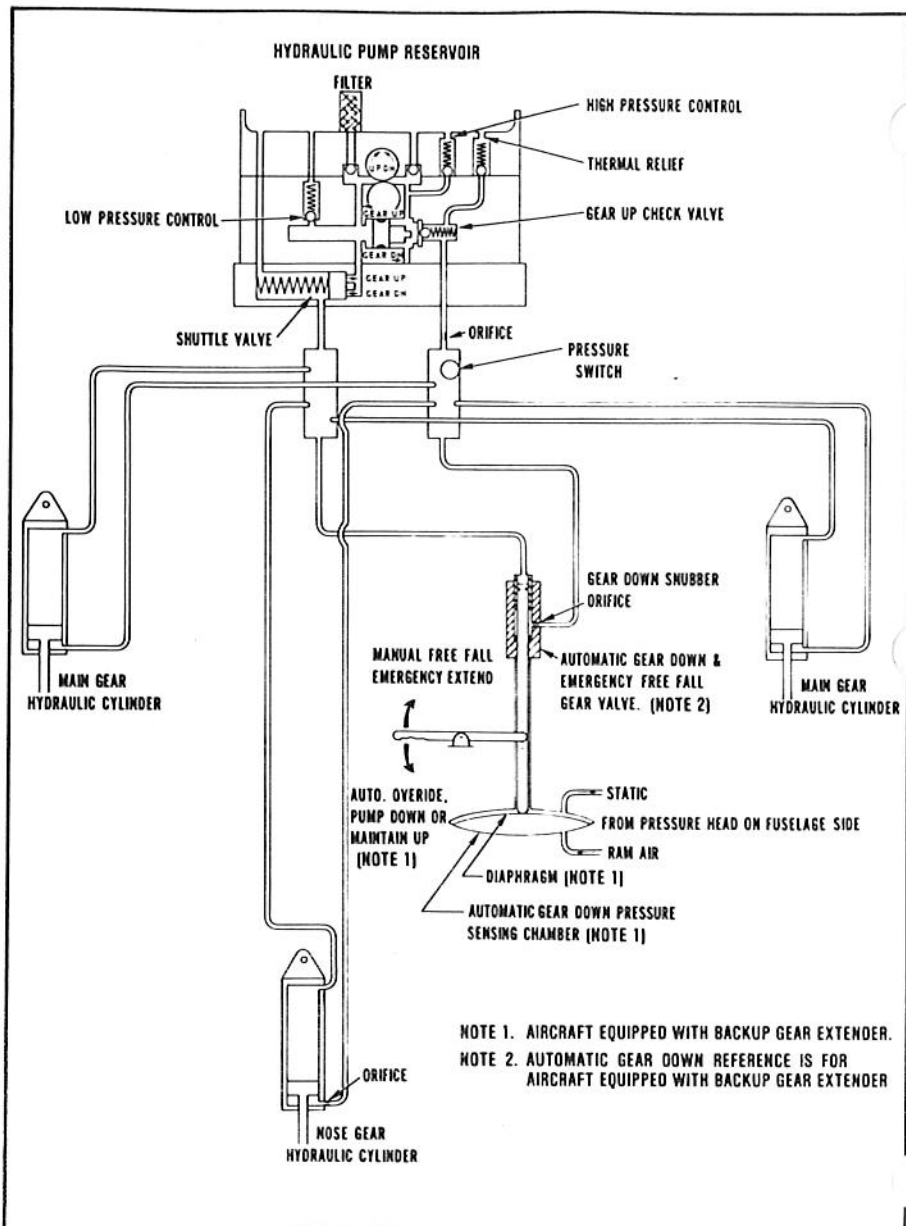

LANDING GEAR HYDRAULIC SCHEMATIC

Figure 7-7

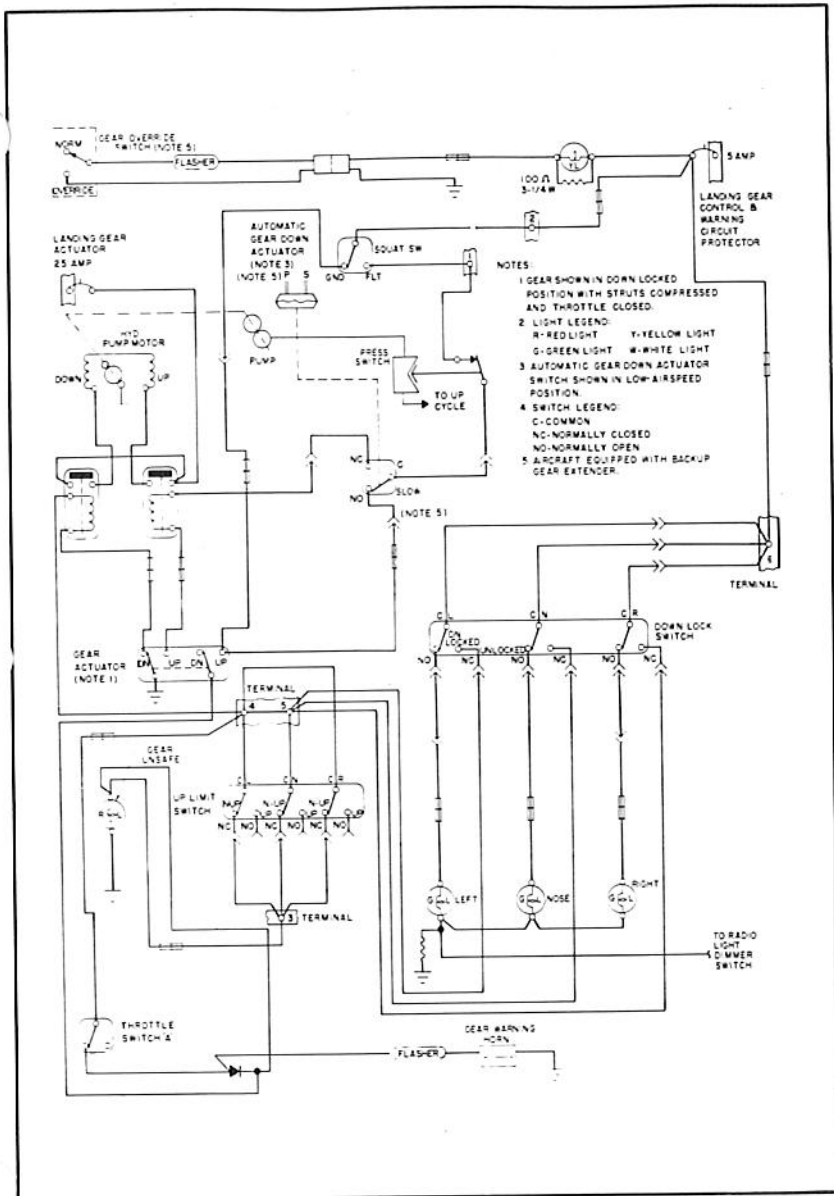

LANDING GEAR ELECTRICAL SCHEMATIC
Figure 7-5

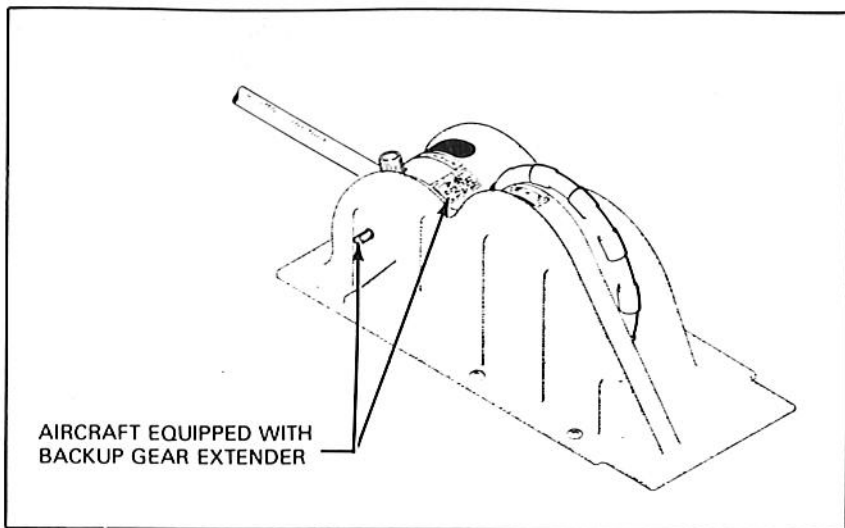

FLIGHT CONTROL CONSOLE

Figure 7-9

7.13 FLIGHT CONTROLS

Dual flight controls are provided as standard equipment. A cable system provides actuation of the control surfaces when the flight controls are moved in their respective directions.

The horizontal surface (stabilator) is mounted atop the fin in a "T" configuration and features a trim tab servo mounted on the trailing edge. This tab serves the dual function of providing trim control and pitch control forces. The trim function is controlled by a trim control wheel located on the control console between the two front seats (Figure 7-9). Rotating the wheel forward gives nose down trim and rotation aft gives nose up trim.

The rudder is conventional in design and incorporates a rudder trim. The trim mechanism is a spring-loaded recentering device. The trim control is located on the right side of the pedestal below the throttle quadrant. Turning the trim control clockwise gives nose right trim and counterclockwise rotation gives nose left trim.

Manually controlled flaps are provided. They are extended by a control cable and are spring-loaded to the retracted (up) position. The control is located between the two front seats on the control console. To extend the flaps pull the handle up to the desired flap setting of 10, 25 or 40 degrees. To retract, depress the button on the end of the handle and lower the control.

When extending or retracting flaps, there is a pitch change in the aircraft. This pitch change can be corrected either by stabilator trim or increased control wheel force. When the flaps are in the retracted position the right flap, provided with a over-center lock mechanism, acts as a step.

NOTE

The right flap will support a load only in the fully retracted (up) position. When loading and unloading passengers make sure the flaps are in the retracted (up) position.

7.15 FUEL SYSTEM

The fuel system was designed with simplicity in mind. It incorporates two fuel tanks, one in each wing containing 38.5 U.S. Gallons, giving a total capacity of 77 gallons, of which 72 gallons are usable. The minimum fuel grade is 100/130 octane (green) or 100LL (blue). The tanks are attached to the leading edge of the wing with screws and are an integral part of the wing structure. This allows removal for service. The tanks are vented individually by a vent tube which protrudes below the bottom of the wing at the rear inboard corner of each tank. The vents should be checked periodically to ascertain that the vent is not obstructed and will allow free passage of air.

Each fuel tank has an individual quick drain located at the bottom inboard rear corner. The fuel strainer also incorporates a quick drain, which is located on the left lower portion of the firewall. The quick drain protrudes thru the cowling to allow easy draining of the fuel strainer. To avoid the accumulation of water and sediment, the fuel tank sumps and strainer should be drained daily prior to first flight and after refueling.

CAUTION

When draining fuel, care should be taken to ensure that no fire hazard exists before starting the engine.

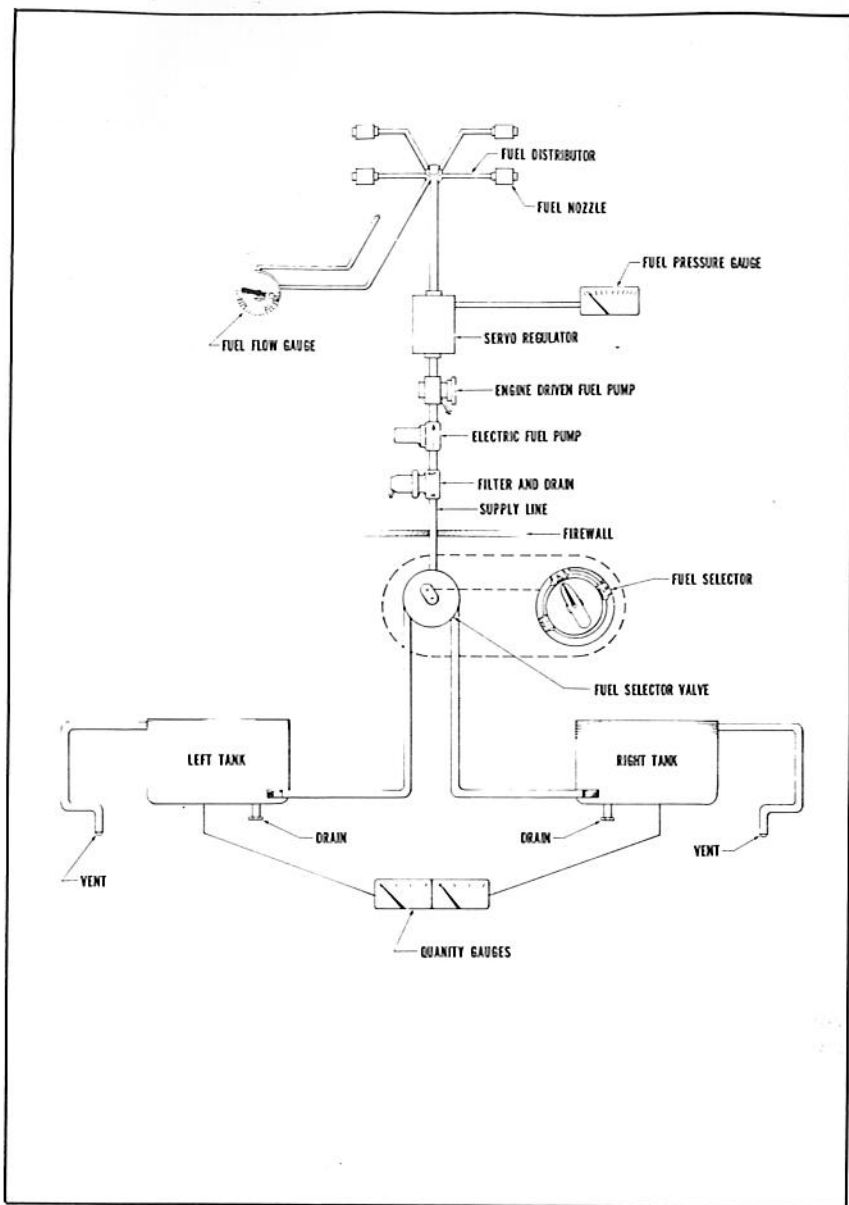

FUEL SYSTEM SCHEMATIC

Figure 7-11

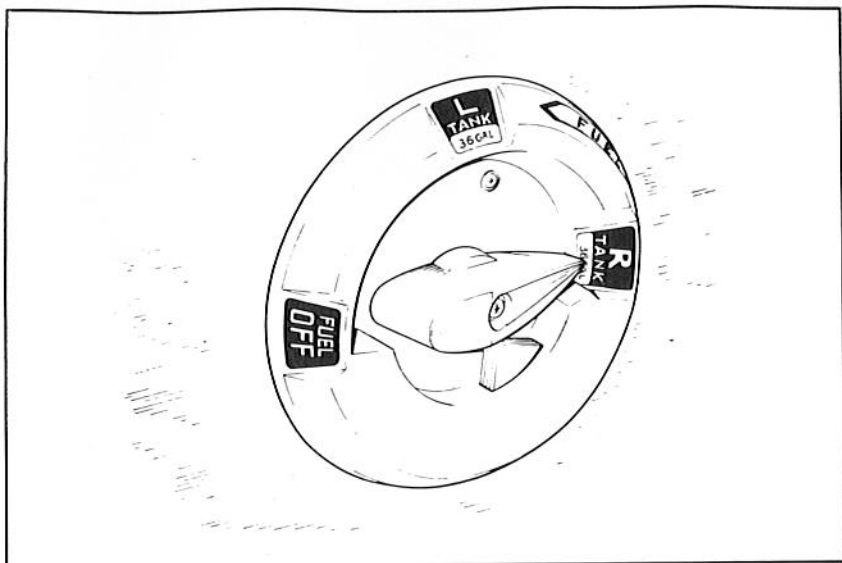

FUEL SELECTOR
Figure 7-13

A fuel tank selector allows the pilot to control the flow of fuel to the engine, and is located on the left side wall below the instrument panel. It has three positions: OFF, LEFT TANK and RIGHT TANK. The arrow on the handle of the selector points to the tank which is supplying fuel to the engine. The valve also incorporates a safety latch which prevents inadvertently selecting the "OFF" position.

Normally fuel is supplied to the engine through an engine-driven fuel pump. An electric fuel pump serves as a back-up feature. The electric fuel pump is controlled by a rocker switch on the switch panel above the throttle quadrant. The electric fuel pump should be ON when switching fuel tanks and during takeoffs and landings.

Fuel quantity and pressure are indicated on gauges on the instrument panel. There is a separate fuel quantity gauge for each tank.

7.17 ELECTRICAL SYSTEM

All switches are grouped in a switch panel above the power quadrant. On the lower right side of the instrument panel is the circuit breaker panel, with each breaker clearly marked to show what circuit it protects. Also, circuit provisions are made to handle the addition of communications and navigational equipment.

Standard electrical accessories include alternator, starter, electric fuel pump, stall warning indicator, ammeter, and annunciator panel.

The annunciator panel includes alternator and low oil pressure indicator lights. When the optional gyro system is installed, the annunciator panel also includes a low vacuum indicator light. The annunciator panel lights are provided only as a warning to the pilot that a system may not be operating properly, and that he should check and monitor the applicable system gauge to determine when or if any necessary action is required.

Optional electrical accessories include navigation anti-collision, landing, instrument and cabin dome lights. Navigation and radio lights are controlled by a rheostat switch on the left side of the switch panel. The instrument panel lights are controlled by a rheostat switch on the right side of the panel.

WARNING

When optional panel lights are installed, rheostat switch must be off to obtain gear lights full intensity during daytime flying. When aircraft is operated at night and panel light rheostat switch is turned on, gear lights will automatically dim.

The anti-collision and landing lights are controlled by rocker switches on the switch panel.

**SECTION 7
DESCRIPTION/OPERATION**

**PIPER AIRCRAFT CORPORATION
PA-28RT-201, ARROW IV**

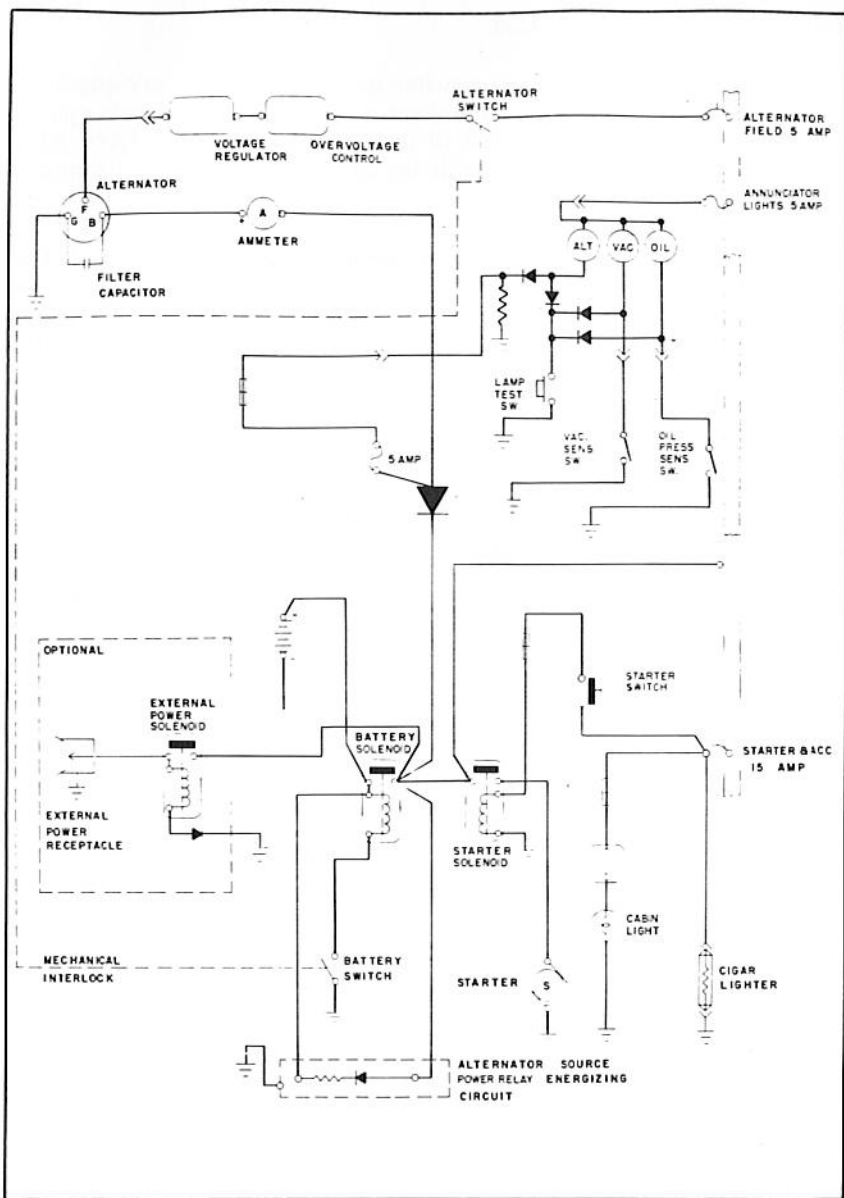

ALTERNATOR AND STARTER SCHEMATIC

Figure 7-15

The primary electrical power source is a 14-volt, 60-amp alternator, which is protected by a voltage regulator and an overvoltage relay. The alternator provides full electrical power output even at low engine RPM. This provides improved radio and electrical equipment operation and increases battery life by reducing battery load.

Secondary power is provided by a 12-volt, 25-ampere hour battery.

The ammeter as installed does not show battery discharge; rather it shows the electrical load placed on the system. With all the electrical equipment off, and the master switch on, the ammeter will indicate the charging rate of the battery. As each electrical unit is switched on, the ammeter will indicate the total ampere draw of all the units including the battery. For example, the average continuous load for night flying with radios on is about 30 amperes. The 30 ampere value plus 2 amperes for charging the battery will then show on the ammeter, indicating the alternator is functioning properly.

Solenoids, provided in the battery and starter circuits, are used to control high current drain functions remotely from the cabin.

7.19 VACUUM SYSTEM

The vacuum system is designed to operate the air driven gyro instruments. This includes the directional and attitude gyros when installed. The system consists of an engine vacuum pump, a vacuum regulator, a filter and the necessary plumbing.

The vacuum pump is a dry type pump which eliminates the need for an air/oil separator and its plumbing. A shear drive protects the engine from damage. If the drive shears the gyros will become inoperative.

The vacuum gauge, mounted on the right instrument panel to the right of the radios, (refer to Figure 7-21) provides valuable information to the pilot about the operation of the vacuum system. A decrease in pressure in a system that has remained constant over an extended period, may indicate a dirty filter, dirty screens, possibly a sticking vacuum regulator or leak in system (a low vacuum indicator light is provided in the annunciator panel). Zero pressure would indicate a sheared pump drive, defective pump, possibly a defective gauge or collapsed line. In the event of any gauge variation from the norm, the pilot should have a mechanic check the system to prevent possible damage to the system components or eventual failure of the system.

A vacuum regulator is provided in the system to protect the gyros. The valve is set so the normal vacuum reads 4.8 to 5.1 inches of mercury, a setting which provides sufficient vacuum to operate all the gyros at their rated RPM. Higher settings will damage the gyros and with a low setting the gyros will be unreliable. The regulator is located behind the instrument panel.

7.21 PITOT-STATIC SYSTEM

The system supplies both pitot and static pressure for the airspeed indicator, altimeter and vertical speed indicator (when installed).

Pitot and static pressure is picked up by the pitot head on the bottom of the left wing. An optional heated pitot head, which alleviates problems with icing or heavy rain, is available. The switch for pitot heat is located on the switch panel. Push-button type pitot and static drains are located on the lower left sidewall of the cockpit.

An alternate static source is available as optional equipment. The control valve is located below the left side of the instrument panel. When the valve is set in the alternate position, the altimeter, vertical speed indicator and airspeed indicator will be using cabin air for static pressure. The storm window and cabin vents must be closed and the cabin heater and defroster must be on during alternate static source operation. The altimeter error is less than 50 feet unless otherwise placarded.

To prevent bugs and water from entering the pitot pressure holes when the airplane is parked, a cover should be placed over the pitot head. A partially or completely blocked pitot head will give erratic or zero readings on the instruments.

NOTE

During preflight, check to make sure the pitot cover is removed.

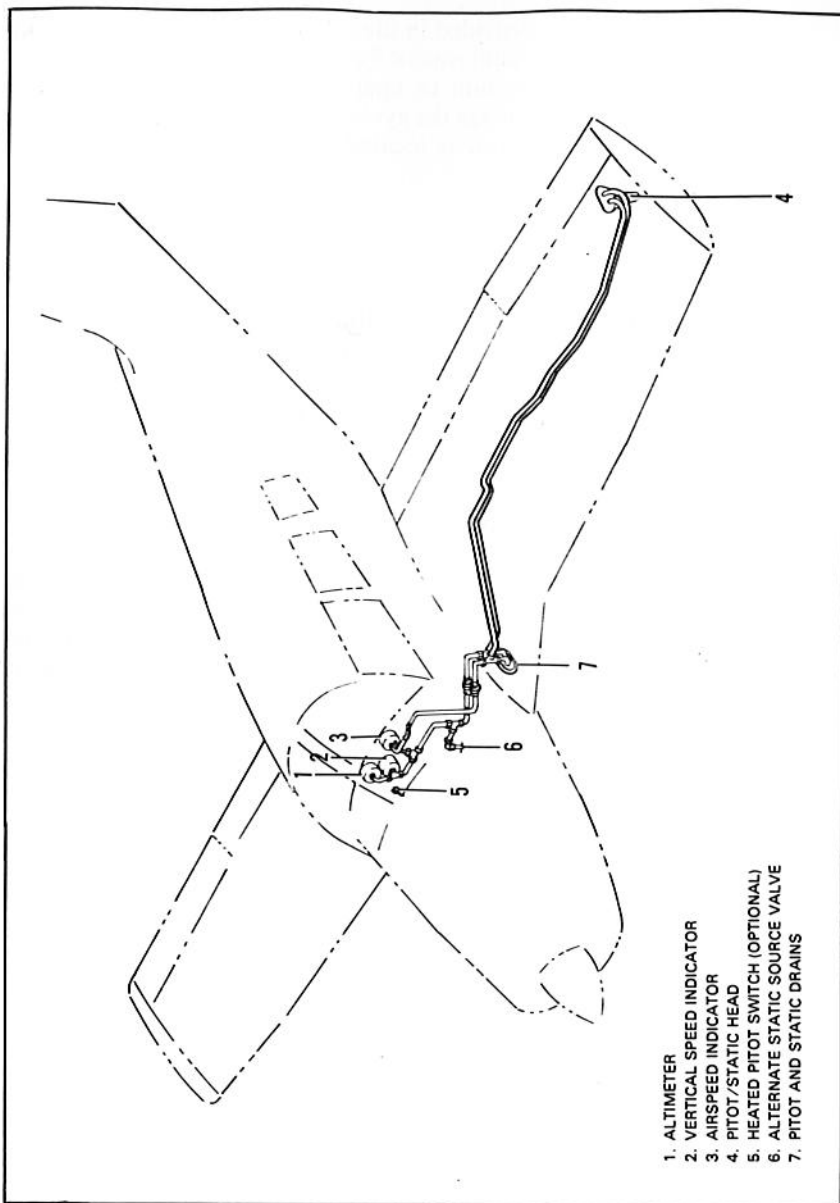

PITOT-STATIC SYSTEM

Figure 7-19

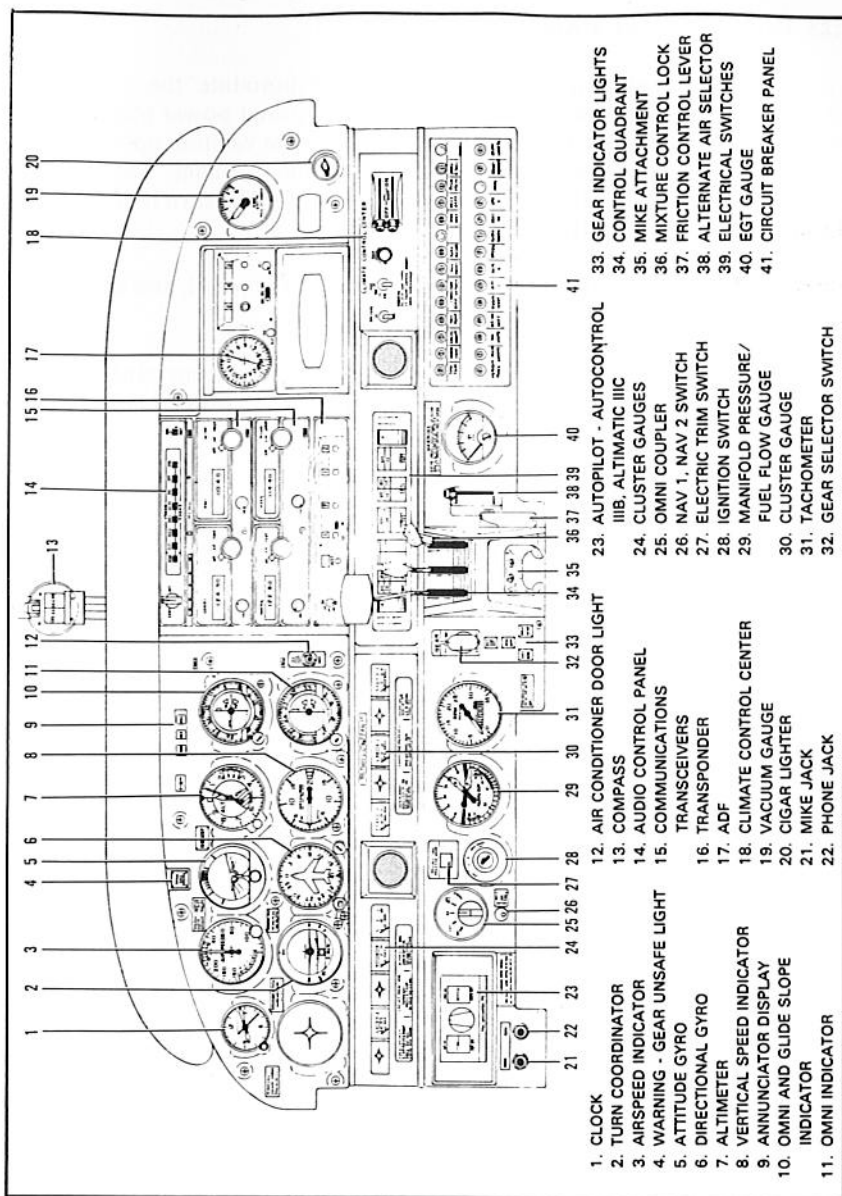

INSTRUMENT PANEL

Figure 7-21

7.23 INSTRUMENT PANEL

The instrument panel is designed to accommodate the customary advanced flight instruments and the normally required power plant instruments. The artificial horizon and directional gyro are vacuum operated and are located in the center of the left hand instrument panel. The vacuum gauge is located on the right hand instrument panel. The turn indicator, on the left side, is electrically operated.

The radios are located in the center section of the panel, and the circuit breakers are in the lower right corner of the panel.

An annunciator panel is mounted in the upper instrument panel to warn the pilot of a possible malfunction in the alternator, oil pressure or vacuum systems.

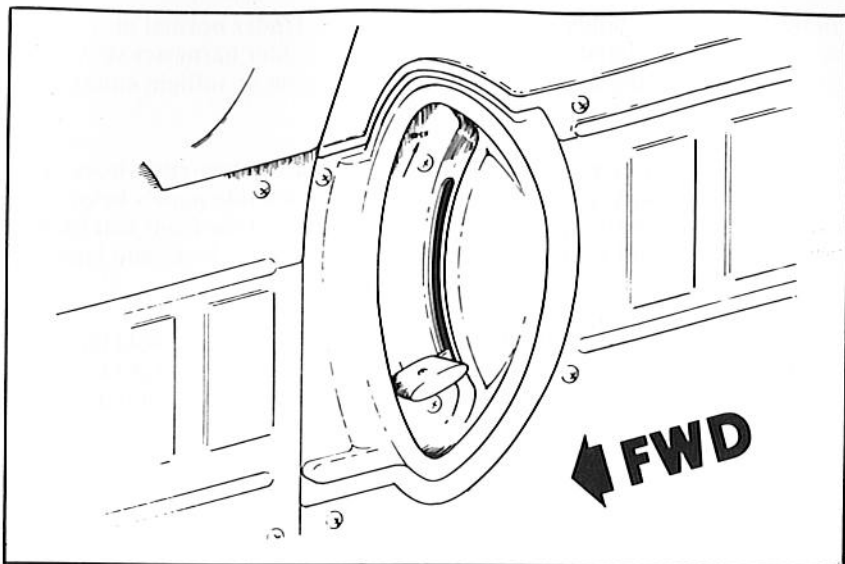

CABIN DOOR LATCH

Figure 7-23

7.25 CABIN FEATURES

All seat backs have three position: normal, intermediate and recline. The adjustment lever is located at the base of the seat back on the outboard side of the seat. The front seats adjust fore and aft for ease of entry and occupant comfort. An armrest is located on the side panels adjacent of the front seat. The rear seats are easily removed to provide room for bulky items. Rear seat installations incorporate leg retainers with latching mechanisms which must be released before the rear seats can be removed. Releasing the retainers is accomplished by depressing the plunger behind each rear leg. Optional headrests are available.

A single strap shoulder harness controlled by an inertial reel, located above the side window, protects each front seat occupant. Optional shoulder straps for the rear occupants are available. The shoulder strap is routed over the shoulder adjacent to the window and attached to the lap belt in the general area of the occupant's inboard hip. A check of the inertia reel mechanism can be made by pulling sharply on the strap and checking that the reel will lock in place under sudden stress; this locking feature prevents the strap

from extending and holds the occupant in place. Under normal movement the strap will extend and retract as required. Shoulder harnesses should be routinely worn during takeoff, landing and whenever an inflight emergency situation occurs.

Additional features include pilot storm window, two sun visors, ash trays for each occupant, map pockets located on the side panels below the instrument panel, miscellaneous pockets on the rear of the front seat backs, armrests for the front occupants, cabin or baggage door locks and ignition lock.

The cabin door is double latched. To close the cabin door, hold the door closed with the arm set while moving the side door latch to the "LATCHED" position. Then engage the top latch. Both latches must be secured before flight.

7.27 BAGGAGE AREA

A large baggage area, located behind the rear seats, is accessible either from the cabin or through a large outside baggage door on the right side of the aircraft. Maximum capacity is 200 lbs. Tie-down straps are provided and should be used at all times.

NOTE

It is the pilot's responsibility to be sure when the baggage is loaded that the aircraft C.G. falls within the allowable C.G. Range. (See Weight and Balance Section.)

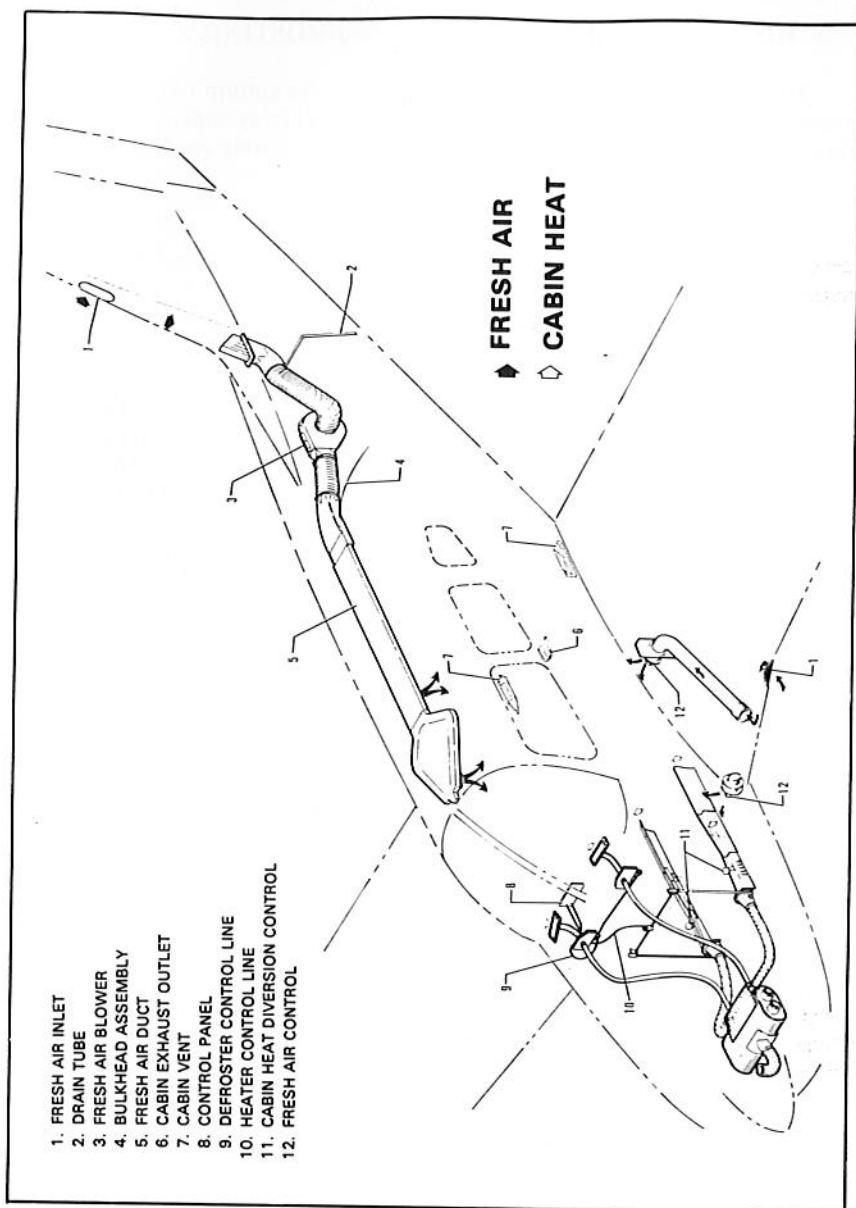

HEATING, VENTILATING AND DEFROSTING SYSTEM

Figure 7-25

7.29 HEATING, VENTILATING AND DEFROSTING SYSTEM

The heating system is designed to provide maximum comfort for the occupants during winter and cool weather flights. The system includes a heat shroud, heat ducts, defroster outlets, heat and defroster controls.

CAUTION

When cabin heat is operated, heat duct surface becomes hot. This could result in burns if arms or legs are placed too close to heat duct outlets or surface.

An opening in the front of the lower cowl admits ram air to the heater shroud and then the air is ducted to the heater shut-offs on the right and left side of the fire wall. When the shut-off's are opened the heated air then enters the heat ducts located along each side of the center console. Outlets in the heat duct are located at each seat location. Airflow to the rear seats can be regulated by controls in the heat ducts located between the front seats. The temperature of the cabin is regulated by the heater control located on the right side of the instrument panel.

Defrosting is accomplished by heat outlets located on the right and left side of the cowl cover. Heated air is ducted directly to defroster shut-off valves at the fire wall, then to the defroster outlets. The airflow is regulated by a defroster control located below the heat control.

To aid air distribution, the cabin air is exhausted overboard by an outlet located on the bottom of the fuselage. Cabin exhaust outlets are located below and outboard of the rear seats. The above features are removed when air conditioning is installed.

Optional individual overhead fresh air outlets supply fresh air from an air inlet located on the tip of the vertical fin. The air is directed to a plenum chamber at the base of the fin, then ducted to the individual outlets. For individual comfort, the amount and direction of air can be regulated to control the amount of air and direction of desired airflow. An optional blower is available which forces outside air through the overhead vents for ground use. The blower is operated by a "FAN" switch with 3 positions - "OFF," "LOW," or "HIGH."

7.31 STALL WARNING

An approaching stall is indicated by a stall warning horn which is activated between five and ten knots above stall speed. Mild airframe buffeting and gentle pitching may also precede the stall. Stall speeds are shown on graphs in the Performance Section. The stall warning horn emits a continuous sound. The landing gear warning horn is different in that it emits a 90 cycle per minute beeping sound. The stall warning horn is activated by a lift detector installed on the leading edge of the left wing. During preflight, the stall warning system should be checked by turning the master switch "ON," lifting the detector and checking to determine if the horn is actuated.

7.33 FINISH

All exterior surfaces are primed with etching primer and finished with acrylic lacquer. To keep the finish attractive looking, economy size spray cans of touch-up paint are available from Piper Dealers.

7.35 AIR CONDITIONING*

The air conditioning system is a recirculating air system. The major components include an evaporator, a condenser, a compressor, a blower, switches and temperature controls.

The evaporator is located behind the rear baggage compartment. This cools the air used for the air conditioning system.

The condenser is mounted on a retractable scoop located on the bottom of the fuselage and to the rear of the baggage compartment area. The scoop extends when the air conditioner is ON and retracts to a flush position when the system is OFF.

The compressor is mounted on the front right side of the engine. It has an electric clutch which automatically engages or disengages the compressor to the belt drive system of the compressor.

Air from the baggage area is drawn through the evaporator by the blower and distributed through an overhead duct to individual outlets located adjacent to each occupant.

*Optional equipment

The switches and temperature control are located on the lower right side of the instrument panel in the climate control center panel. The temperature control regulates the temperature of the cabin. Turning the control clockwise increases cooling; counterclockwise decreases cooling.

The fan speed switch and the air conditioning ON-OFF switch are inboard of the temperature control. The fan can be operated independently of the air conditioning; however, the fan must be on for air conditioner operation. Turning either switch off will disengage the compressor clutch and retract the condenser door. Cooling air should be felt within one minute after the air conditioner is turned on.

NOTE

If the system is not operating in 5 minutes, turn the system OFF until the fault is corrected.

The fan switch allows operation of the fan with the air conditioner turned OFF to aid in cabin air circulation. "LOW" or "HIGH" can be selected to direct a flow of air through the air conditioner outlets in the overhead duct. These outlets can be adjusted or turned off individually.

The condenser door light is located to the right of the engine instrument cluster in front of the pilot. The door light illuminates when the door is open and is off when the door is closed.

A circuit breaker on the circuit breaker panel protects the air conditioning electrical system.

Whenever the throttle is in the full forward position, it actuates a micro switch which disengages the compressor and retracts the scoop. This allows maximum power and maximum rate of climb. The fan continues to operate and the air will remain cool for about one minute. When the throttle is retarded approximately 1/4 inch, the clutch will engage, the scoop will extend, and the system will again supply cool, dry air.

7.37 PIPER EXTERNAL POWER*

An optional starting installation known as Piper External Power (PEP) is accessible through a receptacle located on the right side of the fuselage just aft of the fire wall. An external battery can be connected to the socket, thus allowing the operator to crank the engine without having to gain access to the airplane's battery.

7.39 EMERGENCY LOCATOR TRANSMITTER*

The Emergency Locator Transmitter (ELT) meets the requirements of FAR 91.52. It operates on self-contained batteries and is located in the aft fuselage section. It is accessible through a rectangular cover on the right hand side. A number 2 Phillips screwdriver is required to remove the cover.

A battery replacement date is marked on the transmitter. To comply with FAA regulations, the battery must be replaced on or before this date. The battery must also be replaced if the transmitter has been used in an emergency situation or if the accumulated test time exceeds one hour, or if the unit has been inadvertently activated for an undetermined time period.

NOTE

If for any reason a test transmission is necessary, the test transmission should be conducted only in the first five minutes of any hour and limited to three audio sweeps. If tests must be made at any other time, the tests should be coordinated with the nearest FAA tower or flight service station.

NARCO ELT 10 OPERATION

On the ELT unit itself is a three position switch placarded "ON," "OFF" and "ARM." The ARM position sets the ELT so that it will transmit after impact and will continue to transmit until its battery is drained. The ARM position is selected when the ELT is installed in the airplane and it should remain in that position.

*Optional equipment

To use the ELT as a portable unit in an emergency, remove the cover and unlatch the unit from its mounting base. The antenna cable is disconnected by a left quarter-turn of the knurled nut and a pull. A sharp tug on the two small wires will break them loose. Deploy the self-contained antenna by pulling the plastic tab marked "PULL FULLY TO EXTEND ANTENNA." Move the switch to ON to activate the transmitter.

In the event the transmitter is activated by an impact, it can only be turned off by moving the switch on the ELT unit to OFF. Normal operation can then be restored by pressing the small clear plastic reset button located on the top of the front face of the ELT and then moving the switch to ARM.

A pilot's remote switch located on the left side panel is provided to allow the transmitter to be turned on from inside the cabin. The pilot's remote switch is placarded "ON" and "ARMED." The switch is normally in the ARMED position. Moving the switch to ON will activate the transmitter. Moving the switch back to the ARMED position will turn off the transmitter only if the impact switch has not been activated.

The ELT should be checked to make certain the unit has not been activated during the ground check. Check by selecting 121.50 MHz on an operating receiver. If there is an oscillating chirping sound, the ELT may have been activated and should be turned off immediately. This requires removal of the access cover and moving the switch to OFF, then press the reset button and return the switch to ARM. Recheck with the receiver to ascertain the transmitter is silent.

CCC CIR 11-2 OPERATION

On the unit itself is a three position selector switch placarded "OFF," "ARM" and "ON." The ARM position is provided to set the unit to the automatic position so that it will transmit only after impact and will continue to transmit until the battery is drained to depletion or until the switch is manually moved to the OFF position. The ARM position is selected when the transmitter is installed at the factory and the switch should remain in that position whenever the unit is installed in the airplane. The ON position is provided so the unit can be used as a portable transmitter or in the event the automatic feature was not triggered by impact or to periodically test the function of the transmitter.

Select the OFF position when changing the battery, when rearming the unit if it has been activated for any reason, or to discontinue transmission.

NOTE

If the switch has been placed in the ON position for any reason, the OFF position has to be selected before selecting ARM. If ARM is selected directly from the ON position, the unit will continue to transmit in the ARM position.

A pilot's remote switch, located on the left side panel, is provided to allow the transmitter to be controlled from inside the cabin. The pilot's remote switch is placarded "ON," "AUTO/ARM" and "OFF/RESET." The switch is normally left in the AUTO/ARM position. To turn the transmitter off, move the switch momentarily to the OFF/RESET position. The aircraft master switch must be ON to turn the transmitter OFF. To actuate the transmitter for tests or other reasons, move the switch upward to the ON position and leave it in that position as long as transmission is desired.

The unit is equipped with a portable antenna to allow the locator to be removed from the aircraft in case of an emergency and used as a portable signal transmitter.

The locator should be checked during the ground check to make certain the unit has not been accidentally activated. Check by tuning a radio receiver to 121.50 MHz. If there is an oscillating sound, the locator may have been activated and should be turned off immediately. Reset to the ARM position and check again to insure against outside interference.